

1-800-639-2199

Fax (603) 224-2927

Light Pole Bases\48 Inch Dia x 5 Ft Flagpole Footing

Phoenix Precast Products

Phoenix Precast Products

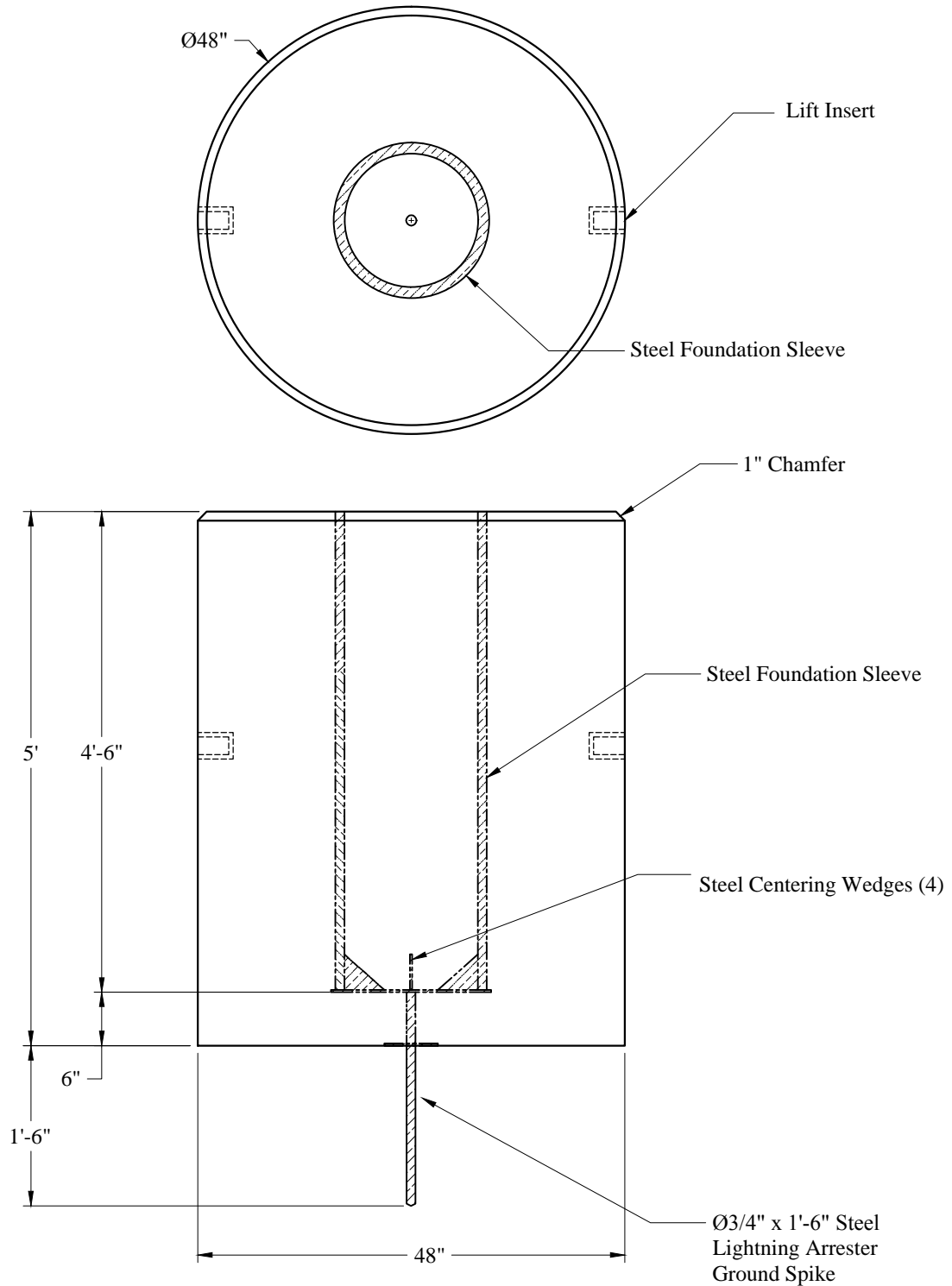

General Notes

1. Concrete: $f_c = 4,000$ psi @ 28 Days Minimum
2. Reinforcement Steel Conforms to:
ASTM A615 Grade 60 Black Deformed Bars
3. Est Weight: 8,800 Lbs

Phoenix
Precast
Products

48"Ø x 5'
Flagpole Footing

P/N: FPB48-5